

# TTV/TTF-G1 TROFFER TRANSFORMER | RETROFIT KIT + NEW FIXTURE | VOLUMETRIC + FLAT PANEL STYLES

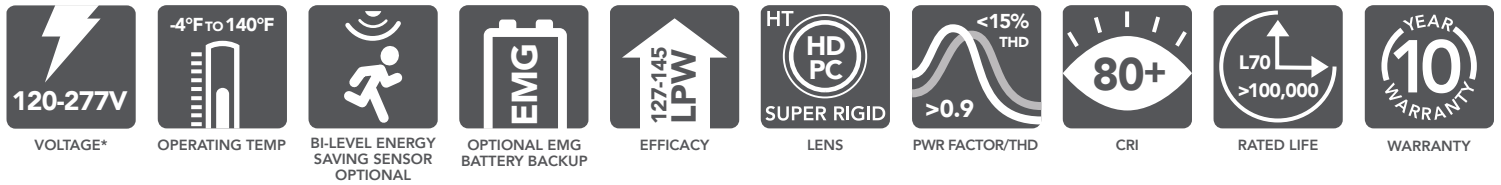

## 1 piece design = easy install



VOLUMETRIC (TTV)

3 sizes to choose from (2x2, 2x4, 1x4)



- ...to have the ability to be installed as a retrofit kit or as a new fixture
- ...is a door style retrofit kit with just one piece, creating a seamless, no air gap look
- ...you can choose from a volumetric or a flat panel design

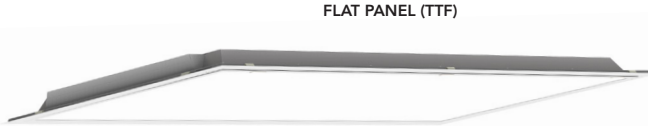

FLAT PANEL (TTF)

**flex**COLOR  
choose from 3 different color temperatures

**flex**WATT  
4 wattages in one product

**flex**CONTROL  
order without controls, with basic sensor, or advanced Bluetooth mesh control

**HOV**  
dimming  
DIM-TO-OFF  
12V DC AUX



Scan here to see how easy it is to install the Troffer Transformer!

### DEFAULT CONFIGURATIONS

PART #	UPC	WATTAGE	LUMENS	LPW	CCT (K)
RP-TTV-G1-2X2-20L-840-FWFC	844006052904	16/20/24/28	2032	127	3500/4000/5000
RP-TTV-G1-1X4-25L-840-FWFC	844006053055	16/20/24/28	2480	127	3500/4000/5000
RP-TTV-G1-2X4-33L-840-FWFC	844006053178	20/26/34/40	3390	130	3500/4000/5000
RP-TTF-G1-2X2-20L-840-FWFC	844006053260	16/20/24/28	2032	127	3500/4000/5000
RP-TTF-G1-1X4-25L-840-FWFC	844006053413	16/20/24/28	2480	124	3500/4000/5000
RP-TTF-G1-2X4-33L-840-FWFC	844006053536	20/26/34/40	3390	130	3500/4000/5000

Must order case quantity of 4



LIGHT EFFICIENT DESIGN HEADQUARTERS 188 S. Northwest Highway • Cary, IL 60013  
INNOVATION & MANUFACTURING CENTER 30 Log Bridge Road, Building 200 • Middleton, MA 01949  
847.380.3540 • led-llc.com

\* 347 voltage optional

# TTV/TTF-G1 TROFFER TRANSFORMER | RETROFIT KIT + NEW FIXTURE | VOLUMETRIC + FLAT PANEL STYLES



TROFFER FEATURES	OUR DESIGN	EVERYONE ELSE
BRACKET DESIGN	Single piece	Multiple bracket pieces
UNIVERSAL TROFFER FIT	Fits every single troffer	Fits some, doesn't fit others
TRIM THAT COVERS UP AIR GAP AROUND FRAME	YES	NO. Ugly air gap depending on the fixture it goes into
FAST 3-MIN INSTALL	YES	NO. 5-15 min or more
DESIGN	Available in both flat panel & volumetric looks	1 or the other
ADJUSTABLE WATTAGE OR COLOR ALL-IN-ONE	YES. FlexWatt & FlexColor	Maybe
CAN BE INSTALLED EITHER AS A RETROFIT OR A NEW FIXTURE	YES. Single product can be used as either	NO. Either purchase door retrofit kit or new fixture

## HOW EASY IS IT TO SET?

Simply open the fixture, and adjust the slide switches with your finger. Takes 30 seconds max



FLEXWATT SLIDE SWITCH POSITION				
SIZE	0	1	2	3
2X2	16W (2000-2032LM)	20W (2500-2540LM)	24W (3072-3120LM)	28W (3584-3640LM)
1X4	16W (1968-2000LM)	20W (2460-2500LM)	24W (3000-3100LM)	28W (3500-3556LM)
2X4	20W (2540-2600LM)	26W (3350-3400LM)	34W (4390-4450LM)	40W (5160-5300LM)



FLEXCOLOR SLIDE SWITCH POSITION			
SIZE	TOP	MIDDLE	BOTTOM
2X2	3500K	4000K	5000K
1X4	3500K	4000K	5000K
2X4	3500K	4000K	5000K

TTF

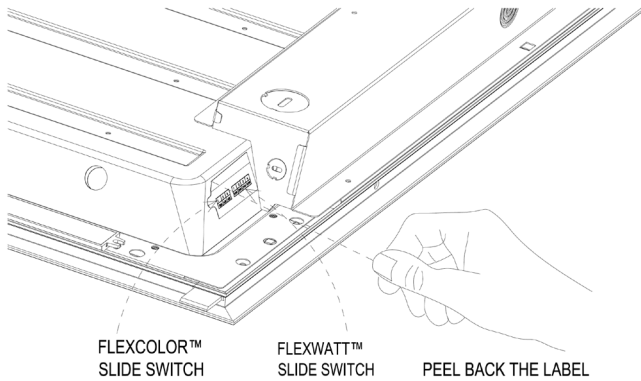

TTV

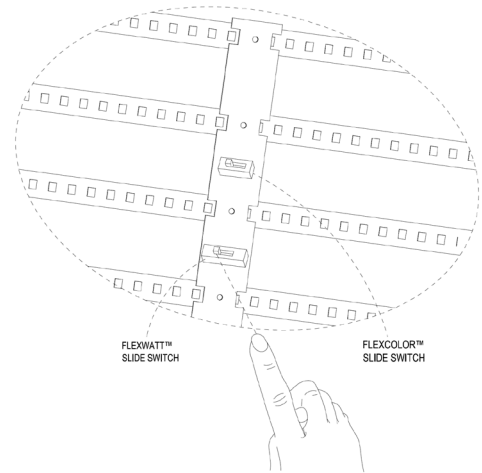

FIXTURE COMES WITH 10V DIMMING;  
DIM-TO-OFF DRIVER W/ 12V DC AUX POWER.

Fixture can be used with Basic PIR fixture level control or advanced Bluetooth Mesh Sensor control system



LIGHT EFFICIENT DESIGN HEADQUARTERS 188 S. Northwest Highway • Cary, IL 60013  
INNOVATION & MANUFACTURING CENTER 30 Log Bridge Road, Building 200 • Middleton, MA 01949  
847.380.3540 • led-llc.com

# TTV/TTF-G1 TROFFER TRANSFORMER | RETROFIT KIT + NEW FIXTURE | VOLUMETRIC + FLAT PANEL STYLES



## PART NUMBER BUILDER

MFR	PRODUCT	GEN	SIZE	WATTAGE	COLOR	FUNCTION	OPTIONS	REV
RP	TTV	G1				FWFC		

### ORDERING EXAMPLE

RP-TTV-G1-2X2-20L-840-FWFC

2X2 → 20L,25L,31L,36L 835=3500K/85CRI  
 1X4 → 20L,25L,31L,36L 840=4000K/85CRI  
 2X4 → 25L,33L,43L,53L 850=5000K/85CRI

FWFC= FlexWatt + FlexColor

-OCC=high/low motion sensor  
 -EMG=90min emergency battery backup  
 -AIR = Air Return Trim  
 -Advanced control options available, call for more information



If you require BAA (ARRA Section 1605) add -AA at end of part number.

For BAA projects, please contact our projects quotations team.

SURFACE MOUNT ACCESSORIES
RPT-LEDPANEL-SMK-2X2
RPT-LEDPANEL-SMK-1X4
RPT-LEDPANEL-SMK-2X4

**DEFAULT LUMEN PACKAGE (WATTAGE AND CCT) ARE SHOWN BELOW IN BOLD.** There are two ways to achieve a non-default lumen package and/or CCT -  
 1. You can easily adjust in field via our FlexWatt and FlexColor internal switches. 2. Have us adjust the FlexWatt and FlexColor at the factory for an additional charge.

## ORDERING GUIDE

PART #	UPC	WATTAGE	LUMENS	CCT (K)	DLC CODES
RP-TTV-G1-2X2-20L-835-FWFC	844006052898	16	2000	3500	PO3AXSOR
<b>RP-TTV-G1-2X2-20L-840-FWFC</b>	844006052904	<b>16</b>	<b>2032</b>	<b>4000</b>	<b>PO3AXSOR</b>
RP-TTV-G1-2X2-20L-850-FWFC	844006052911	16	2032	5000	PO3AXSOR
RP-TTV-G1-2X2-25L-835-FWFC	844006052928	20	2500	3500	PPFL3XHO
RP-TTV-G1-2X2-25L-840-FWFC	844006052935	20	2540	4000	PPFL3XHO
RP-TTV-G1-2X2-25L-850-FWFC	844006052942	20	2540	5000	PPFL3XHO
RP-TTV-G1-2X2-31L-835-FWFC	844006052959	24	3072	3500	PWCUHU54
RP-TTV-G1-2X2-31L-840-FWFC	844006052966	24	3120	4000	PWCUHU54
RP-TTV-G1-2X2-31L-850-FWFC	844006052973	24	3120	5000	PWCUHU54
RP-TTV-G1-2X2-36L-835-FWFC	844006052980	28	3584	3500	PR7NEREO
RP-TTV-G1-2X2-36L-840-FWFC	844006052997	28	3640	4000	PR7NEREO
RP-TTV-G1-2X2-36L-850-FWFC	844006053000	28	3640	5000	PR7NEREO
RP-TTV-G1-1X4-20L-835-FWFC	844006053017	16	1968	3500	P5037N4T
RP-TTV-G1-1X4-20L-840-FWFC	844006053024	16	1984	4000	P5037N4T
RP-TTV-G1-1X4-20L-850-FWFC	844006053031	16	2000	5000	P5037N4T
RP-TTV-G1-1X4-25L-835-FWFC	844006053048	20	2460	3500	PU2SVMZT
<b>RP-TTV-G1-1X4-25L-840-FWFC</b>	844006053055	<b>20</b>	<b>2480</b>	<b>4000</b>	<b>PU2SVMZT</b>
RP-TTV-G1-1X4-25L-850-FWFC	844006053062	20	2500	5000	PU2SVMZT
RP-TTV-G1-1X4-31L-835-FWFC	844006053079	24	3000	3500	PKRUN42H
RP-TTV-G1-1X4-31L-840-FWFC	844006053086	24	3048	4000	PKRUN42H
RP-TTV-G1-1X4-31L-850-FWFC	844006053093	24	3100	5000	PKRUN42H
RP-TTV-G1-1X4-36L-835-FWFC	844006053109	28	3500	3500	PDPFGCTQ
RP-TTV-G1-1X4-36L-840-FWFC	844006053116	28	3556	4000	PDPFGCTQ
RP-TTV-G1-1X4-36L-850-FWFC	844006053123	28	3556	5000	PDPFGCTQ
RP-TTV-G1-2X4-25L-835-FWFC	844006053130	20	2540	3500	PCLVX21E
RP-TTV-G1-2X4-25L-840-FWFC	844006053147	20	2600	4000	PCLVX21E
RP-TTV-G1-2X4-25L-850-FWFC	844006053154	20	2600	5000	PCLVX21E
RP-TTV-G1-2X4-33L-835-FWFC	844006053161	26	3350	3500	PW8NFK1Q
<b>RP-TTV-G1-2X4-33L-840-FWFC</b>	844006053178	<b>26</b>	<b>3390</b>	<b>4000</b>	<b>PW8NFK1Q</b>
RP-TTV-G1-2X4-33L-850-FWFC	844006053185	26	3400	5000	PW8NFK1Q
RP-TTV-G1-2X4-43L-835-FWFC	844006053192	34	4390	3500	PY1WJ5ZX
RP-TTV-G1-2X4-43L-840-FWFC	844006053208	34	4450	4000	PY1WJ5ZX
RP-TTV-G1-2X4-43L-850-FWFC	844006053215	34	4450	5000	PY1WJ5ZX
RP-TTV-G1-2X4-53L-835-FWFC	844006053222	40	5160	3500	P80XVTA2
RP-TTV-G1-2X4-53L-840-FWFC	844006053239	40	5300	4000	P80XVTA2
RP-TTV-G1-2X4-53L-850-FWFC	844006053246	40	5300	5000	P80XVTA2



LIGHT EFFICIENT DESIGN HEADQUARTERS 188 S. Northwest Highway • Cary, IL 60013  
 INNOVATION & MANUFACTURING CENTER 30 Log Bridge Road, Building 200 • Middleton, MA 01949  
 847.380.3540 • led-llc.com

# TTV/TTF-G1 TROFFER TRANSFORMER | RETROFIT KIT + NEW FIXTURE | VOLUMETRIC + FLAT PANEL STYLES



## PART NUMBER BUILDER

MFR	PRODUCT	GEN	SIZE	WATTAGE	COLOR	FUNCTION	OPTIONS	REV
RP	TTF	G1				FWFC		

### ORDERING EXAMPLE

RP-TTF-G1-2X2-20L-840-FWFC

2X2 → 20L,25L,31L,36L 835=3500K/85CRI FWFC= FlexWatt + FlexColor  
 1X4 → 20L,25L,31L,36L 840=4000K/85CRI  
 2X4 → 25L,33L,43L,53L 850=5000K/85CRI

-OCC=high/low motion sensor  
 -EMG=90min emergency battery backup  
 -AIR = Air Return Trim  
 -Advanced control options available, call for more



If you require BAA (ARRA Section 1605) add -AA at end of part number.

#### SURFACE MOUNT ACCESSORIES

RPT-LEDPANEL-SMK-2X2  
 RPT-LEDPANEL-SMK-1X4  
 RPT-LEDPANEL-SMK-2X4

For BAA projects, please contact our projects quotations team.

DEFAULT LUMEN PACKAGE (WATTAGE AND CCT) ARE SHOWN BELOW IN BOLD. There are two ways to achieve a non-default lumen package and/or CCT -  
 1. You can easily adjust in field via our FlexWatt and FlexColor internal switches. 2. Have us adjust the FlexWatt and FlexColor at the factory for an additional charge.

## ORDERING GUIDE

PART #	UPC	WATTAGE	LUMENS	CCT (K)	DLC CODES
RP-TTF-G1-2X2-20L-835-FWFC	844006053253	16	2000	3500	PDJZ455J
<b>RP-TTF-G1-2X2-20L-840-FWFC</b>	844006053260	<b>16</b>	<b>2032</b>	<b>4000</b>	<b>PDJZ455J</b>
RP-TTF-G1-2X2-20L-850-FWFC	844006053277	16	2032	5000	PDJZ455J
RP-TTF-G1-2X2-25L-835-FWFC	844006053284	20	2500	3500	PSCTWQJJ
RP-TTF-G1-2X2-25L-840-FWFC	844006053291	20	2540	4000	PSCTWQJJ
RP-TTF-G1-2X2-25L-850-FWFC	844006053307	20	2540	5000	PSCTWQJJ
RP-TTF-G1-2X2-31L-835-FWFC	844006053314	24	3072	3500	PCHWMOEF
RP-TTF-G1-2X2-31L-840-FWFC	844006053321	24	3120	4000	PCHWMOEF
RP-TTF-G1-2X2-31L-850-FWFC	844006053338	24	3120	5000	PCHWMOEF
RP-TTF-G1-2X2-36L-835-FWFC	844006053345	28	3584	3500	P21BZH1B
RP-TTF-G1-2X2-36L-840-FWFC	844006053352	28	3640	4000	P21BZH1B
RP-TTF-G1-2X2-36L-850-FWFC	844006053369	28	3640	5000	P21BZH1B
RP-TTF-G1-1X4-20L-835-FWFC	844006053376	16	1968	3500	PVY1ZQ7X
RP-TTF-G1-1X4-20L-840-FWFC	844006053383	16	1984	4000	PVY1ZQ7X
RP-TTF-G1-1X4-20L-850-FWFC	844006053390	16	2000	5000	PVY1ZQ7X
RP-TTF-G1-1X4-25L-835-FWFC	844006053406	20	2460	3500	PD859M44
<b>RP-TTF-G1-1X4-25L-840-FWFC</b>	844006053413	<b>20</b>	<b>2480</b>	<b>4000</b>	<b>PD859M44</b>
RP-TTF-G1-1X4-25L-850-FWFC	844006053420	20	2500	5000	PD859M44
RP-TTF-G1-1X4-31L-835-FWFC	844006053437	24	3000	3500	PPBUV9Z0
RP-TTF-G1-1X4-31L-840-FWFC	844006053444	24	3048	4000	PPBUV9Z0
RP-TTF-G1-1X4-31L-850-FWFC	844006053451	24	3100	5000	PPBUV9Z0
RP-TTF-G1-1X4-36L-835-FWFC	844006053468	28	3500	3500	PEGDQWS7
RP-TTF-G1-1X4-36L-840-FWFC	844006053475	28	3556	4000	PEGDQWS7
RP-TTF-G1-1X4-36L-850-FWFC	844006053482	28	3556	5000	PEGDQWS7
RP-TTF-G1-2X4-25L-835-FWFC	844006053499	20	2540	3500	PQDQB5GM
RP-TTF-G1-2X4-25L-840-FWFC	844006053505	20	2600	4000	PQDQB5GM
RP-TTF-G1-2X4-25L-850-FWFC	844006053512	20	2600	5000	PQDQB5GM
RP-TTF-G1-2X4-33L-835-FWFC	844006053529	26	3350	3500	PAVIL5O9
<b>RP-TTF-G1-2X4-33L-840-FWFC</b>	844006053536	<b>26</b>	<b>3390</b>	<b>4000</b>	<b>PAVIL5O9</b>
RP-TTF-G1-2X4-33L-850-FWFC	844006053543	26	3400	5000	PAVIL5O9
RP-TTF-G1-2X4-43L-835-FWFC	844006053550	34	4390	3500	P8NYRB0G
RP-TTF-G1-2X4-43L-840-FWFC	844006053567	34	4450	4000	P8NYRB0G
RP-TTF-G1-2X4-43L-850-FWFC	844006053574	34	4450	5000	P8NYRB0G
RP-TTF-G1-2X4-53L-835-FWFC	844006053581	40	5160	3500	P1EQNH2C
RP-TTF-G1-2X4-53L-840-FWFC	844006053598	40	5300	4000	P1EQNH2C
RP-TTF-G1-2X4-53L-850-FWFC	844006053604	40	5300	5000	P1EQNH2C



LIGHT EFFICIENT DESIGN HEADQUARTERS 188 S. Northwest Highway • Cary, IL 60013  
 INNOVATION & MANUFACTURING CENTER 30 Log Bridge Road, Building 200 • Middleton, MA 01949  
 847.380.3540 • led-llc.com

## TROFFER TRANSFORMER INSTALLATION GUIDE (RETROFIT)

### 1. SHUT OFF POWER TO THE FIXTURE

Open the fixture lens and remove the existing fluorescent lamps, ballast cover and lens. Disconnect the ballast from the building's line voltage.



### 2. INSTALL SAFETY ANCHOR TO THE EXISTING FIXTURE

Using the supplied (2) anchor brackets and (2) self-drilling screws, attach anchor to the fixture housing.

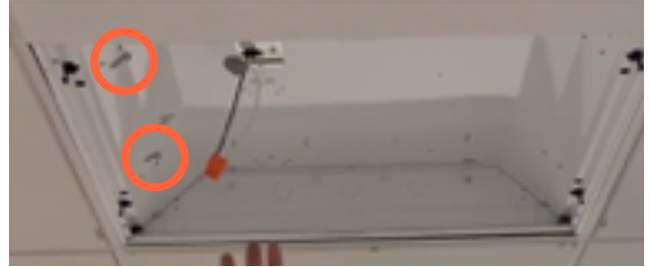

### 3. ATTACH CARABINERS/SAFETY CABLES

Use the (2) carabiners to connect to the Troffer Transformer safety cables to the anchor points. Now the fixture will be hanging in place to make the install easier. For install onto narrow T-Grid – install centering tabs to holes on trim for guarantee straight fit.



### 4. MAKE ELECTRICAL CONNECTIONS

Connect input power via the included quick disconnect.

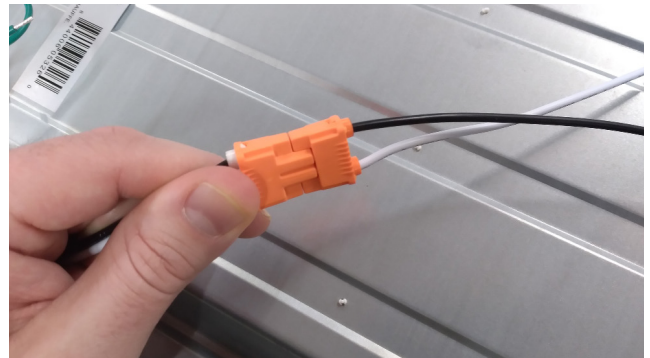

### 5. INSTALL KNIFE-EDGE

Align the knife-edge of the Troffer Transformer with the T-bar grid and push. The knife will be sandwiched between the T-bar and the old fixture.



### 6. COMPLETE THE INSTALL

Push the other side of the Troffer Transformer up into the existing fixture. With a TORX T30 screwdriver rotate corner screws 1/2 turn (180°) to secure the Troffer-Transformer in place with expanding latch. (2x4 center latch is 1/4 turn - 90°) Install adhesive cover to T30 latch for smooth look. Turn power ON and install is complete!



# TTV/TTF-G1 TROFFER TRANSFORMER | RETROFIT KIT + NEW FIXTURE | VOLUMETRIC + FLAT PANEL STYLES



## -AIR

Use the Troffer Transformer Air Return Option (...-AIR) on flat panel or volumetric versions to include air return slots in the fixture trim.



AIR RETURN SLOTS

## TTV DIMENSIONS

### 1X4

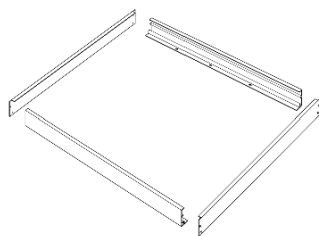
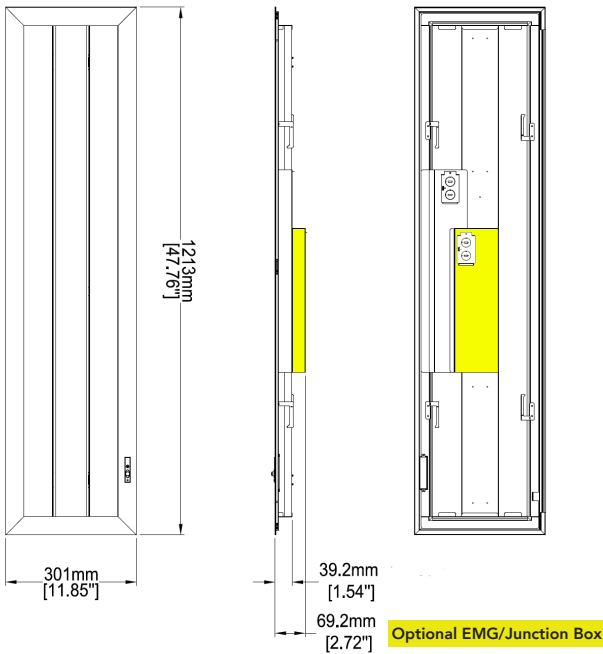

SURFACE MOUNT KIT ACCESSORY (2X2 SHOWN)  
HEIGHT/DEPTH OF KIT 2.25"

### 2X2

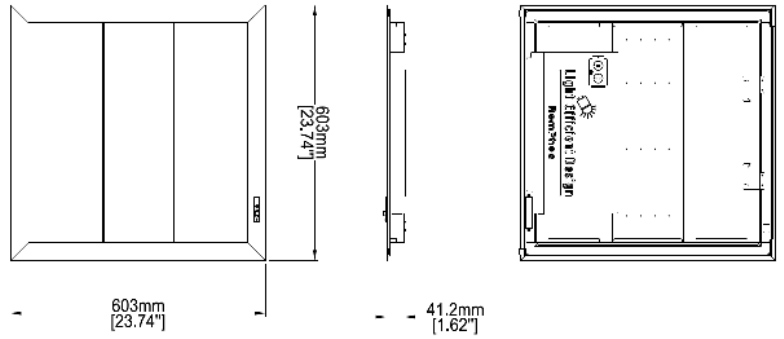

### 2X4

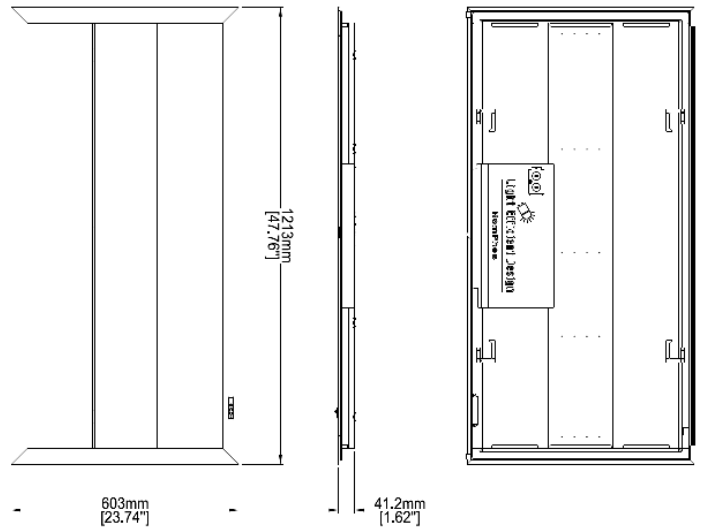

**Light Efficient Design**

LIGHT EFFICIENT DESIGN HEADQUARTERS 188 S. Northwest Highway • Cary, IL 60013  
INNOVATION & MANUFACTURING CENTER 30 Log Bridge Road, Building 200 • Middleton, MA 01949  
847.380.3540 • led-llc.com

# TTV/TTF-G1 TROFFER TRANSFORMER | RETROFIT KIT + NEW FIXTURE | VOLUMETRIC + FLAT PANEL STYLES



## -AIR

Use the Troffer Transformer Air Return Option (...-AIR) on flat panel or volumetric versions to include air return slots in the fixture trim.



AIR RETURN SLOTS

## TTF DIMENSIONS

### 1X4

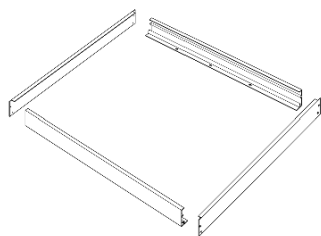
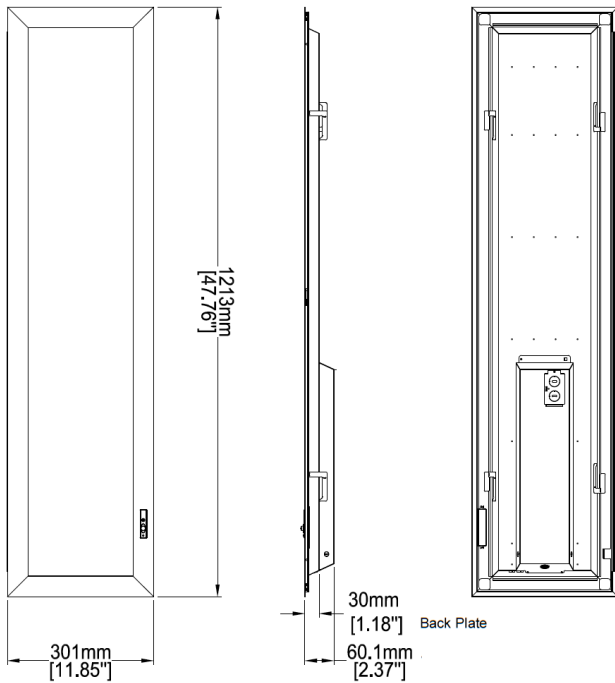

SURFACE MOUNT KIT ACCESSORY (2X2 SHOWN)  
HEIGHT/DEPTH OF KIT 2.25"

### 2X2

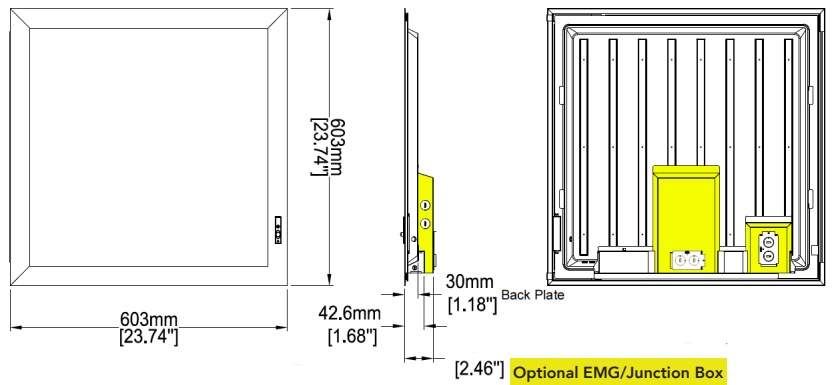

### 2X4

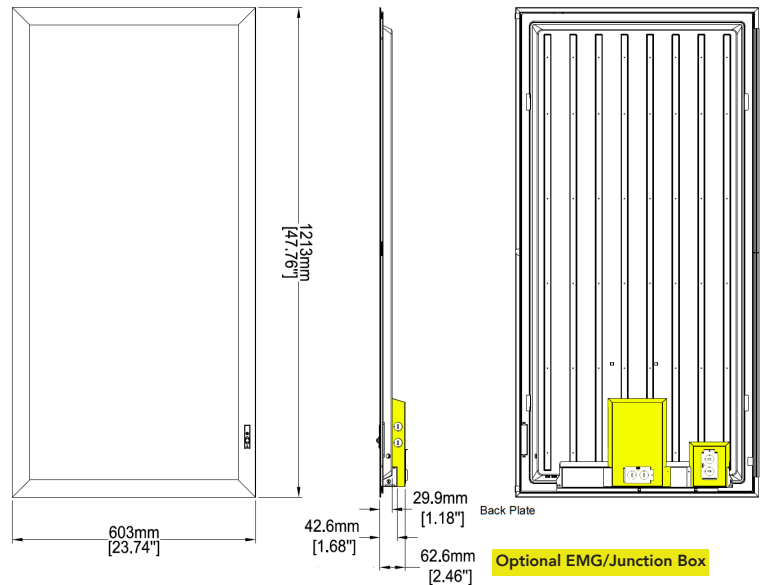

**Light Efficient Design**

LIGHT EFFICIENT DESIGN HEADQUARTERS 188 S. Northwest Highway • Cary, IL 60013  
INNOVATION & MANUFACTURING CENTER 30 Log Bridge Road, Building 200 • Middleton, MA 01949  
847.380.3540 • led-llc.com

06.15.21 Information is subject to change without notice.



## Remote Control Settings

If satisfied with default settings, remote control is not needed. If settings need to be changed, optional remote control (RP-OC2-REMOTE-IR11), is required.



### PERMANENT ON FUNCTION

Microwave signal disabled  
Press 'ON' button, fixture goes to permanent on mode, sensor is disabled.  
With memory function against power failure.  
\* Press 'Auto' or 'Reset' to quit this mode.



### PERMANENT OFF FUNCTION

Microwave signal disabled  
Press 'OFF' button, fixture goes to permanent off mode, sensor is disabled.  
With memory function against power failure  
\* Press 'Auto' or 'Reset' learn' to quit this mode.



### SENSOR MODE

Press 'Auto' button, the sensor starts to work and all settings remain the same as the latest status before the light was switched on/off.



### RESET FUNCTION

Press 'Reset' button, all settings go back to factory default settings.

### FACTORY DEFAULT SETTINGS - REMOTE REQUIRED TO CHANGE SETTINGS

Daylight sensor=disable  
Hold time=5min  
Twilight time=+∞  
Twilight level=30%

**NOTE** daylight harvest function is disabled in factory default mode. Choose the appropriate lux threshold first to activate the daylight harvest function.



### DISABLE DAYLIGHT SENSOR

Press 'Disable' button, the daylight sensor will be disabled, the motion sensor will work always, even in daytime.



### TEST MODE

Test mode' is used for testing purpose only, for users to check the detection range.

\*\*Quit test mode by pressing any other button of 'Hold time'. The sensor settings are changed accordingly.

### TEST MODE SETTINGS

Daylight sensor=disable  
Hold time=3s  
Twilight time=N/A  
Twilight level=N/A



Sensitivity section not used

IR11

- The light will blink (~0.5s) ONCE when sensor successfully receives RC signal after pressing any valid button.
- When "twilight level" set at 0%, it becomes ON/OFF control.